



PRODUCTS

GLOBAL SOLUTIONS
FOR HEAVY MACHINERY



2019
Acquisition of the companies, Bateman Manufacturing and Winkle Industries.

A new, 24,000 sq. Ft. extension is added to the GRYB facility.

2017
Following a new extension, the company now has a facility totalling 69,000 sq. Ft.

2016
Groupe R-Y Beaudoin becomes GRYB.

2015
Acquisition of Magnet Quebec.

2014
A new 23,000 sq. Ft. factory is constructed.

2013
A new range of products is developed, including a screening bucket and a concrete pulverizer.

2010
Equipment upgrade, including the addition of a welding robot and CNC lathe.

2009
Inauguration of a new 10,000 sq. Ft. facility.

2007
Groupe R-Y Beaudoin is established.

WE MANUFACTURE A COMPLETE LINE OF DURABLE, HIGH-EFFICIENCY HEAVY EQUIPMENT ATTACHMENTS.

RECOGNIZED FOR OUR DEVOTION AND EASE OF COLLABORATION, WE ARE CONSTANTLY LOOKING FOR NEW, INNOVATIVE SOLUTIONS.

Through each of our 5 divisions, ATTACHMENTS, MAGNETIC, HANDLING, LIFTING and MACHINE MODIFICATIONS, we stand out by adapting our products to all active machines on the market in addition to realizing a multitude of personalized projects which has made us renown from the beginning.



Our efforts are focused on quick execution and delivery that surpasses that of our competition, while providing personable individualized customer service. We work in close collaboration with our clients in order to simplify their daily requirements.



We offer a multitude of solutions!

Custom and turnkey projects, financing options, equipment loans, and bits of advice!

All solutions are good when it comes to simplifying the large-scale projects of our clientele. Our corporate culture is innovation-based and our clients reap the benefits.

SERVICE PROJECT

REFURBISHMENT AND REPAIR

WE OFFER REPAIR AND RECONDITIONING SERVICES FOR YOUR ATTACHMENT

Even if it is not a GRYB attachment, it is with great pleasure and efficiency that we will fix it thanks to our competent team!

Whether it's a parts replacement, an addition piece, or a modification to improve your attachment, GRYB is committed to meet all your specifications.

GRYB IS A PASSIONATE, INNOVATIVE, AND DYNAMIC TEAM!

Coordinated to respond quickly and efficiently to all customers.

Our team of representatives and on-the-road technicians are always available.

SPECIAL APPLICATION PRODUCT

OUR DEPARTMENT OF DESIGN AND TAILOR-MADE MANUFACTURING IS SPECIALIZED IN CUSTOM PROJECTS.

From a simple sketch on a napkin, we can offer you designs adapted to your specific needs. We transform your ambitions into reality thanks to our impressive team of engineers and draughtsman entirely dedicated to our customer's projects.

Our team never backs down from a request, every custom project is considered a stimulating challenge, and everything is done to surpass the expectations of our customers.

Contact our sales team to see your ideas come to life!

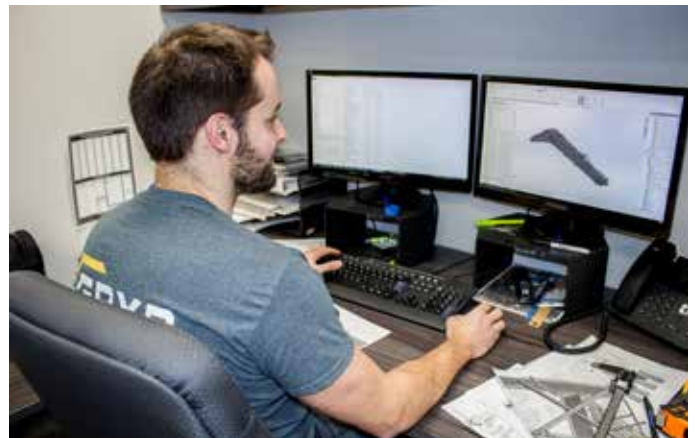



ATTACHMENTS
DIVISION \GRYB

MAGNETICS
DIVISION \GRYB

HANDLING
DIVISION \GRYB



GLOBAL SOLUTIONS FOR HEAVY MACHINERY

MACHINE MODIFICATIONS
DIVISION \GRYB

LIFTING
DIVISION \GRYB



TABLE OF CONTENTS

ATTACHMENTS DIVISION \ GRYB	
EXCAVATOR	
REVERSIBLE QUICK-COUPLER	8
QUICK HITCH PIN GRABBER STRUCTURE	8
TILTING QUICK-COUPLER	9
STANDARD FEMALE COUPLER	10
CONCRETE PULVERISER	12
SCREENING BUCKET	14
EXTREME HEAVY DUTY BUCKET	18
4-IN-1 BUCKET	19
TILT DITCHING BUCKET	20
DITCHING BUCKET	21
SKELETON BUCKET TRAPEZOIDAL BUCKET	22
RECESSED BUCKET ROOT RAKE	23
RIPPER STUMP SHEARS	24
HYDRAULIC THUMB ON AXLE SUPPORT	25
LOADER	
QUICK-COUPLER	26
FEMALE COUPLERS	27
EXTREME-USE ROCK BUCKET	28
HIGH DUMP BUCKET	29
LIGHT MATERIALS BUCKET	30
SIDE DUMP BUCKET	32
GRAPPLE BUCKET	33
SKELETON BUCKET	34
UNDERCARRIAGE	35
JIB BOOM	36
ROTATING ICEBREAKER	38
DIRECTIONAL SNOW PUSHER	40
REVERSIBLE SNOW PUSHER	41

BACKHOES	
FRONT END ATTACHMENTS	42
BACKHOE ATTACHMENTS	44
MAGNETICS DIVISION \ GRYB	
SCRAP MAGNET POWERGRIP	48
SCRAP MAGNET XTREMGRIP	50
HYDRAULIC MAGNET	52
BATTERY MAGNET	53
HANDLING MAGNETS	54
PERMANENT MAGNETIC SEPARATOR	56
ELECTROMAGNETICS MAGNETIC SEPARATOR	57
PERMANENT MAGNETIC PULLEY DRUM	58
PERMANENT MAGNETIC SWEEPER	59
HYDRAULIC GENERATOR	60
DIESEL GENERATOR	61
MAGNETIC BUCKET	62
HYDRAULIC PULVERISER	63
MAGNETS SPECIFICATIONS	64
LIFTING DIVISION \ GRYB	
C-HOOK PRONG	69
SPREADER BEAM CONTAINER SPREADER FRAME	70
TEST STATION	71
MACHINE MODIFICATIONS DIVISION \ GRYB	
LONG REACH	74
HIGH REACH ARM	76
DEMOLITION ARM	77
BOOM AND STICK	78
BOOM AND STICK EXTENSION	79
SPECIALIZED ARM FOR HANDLING MATERIALS	80
SPECIAL PROJECTS	81

ATTACHMENTS

DIVISION \GRYB



CONSTRUCTION



DEMOLITION



RECYCLING



SNOW REMOVAL



HANDLING



MINING INDUSTRIES

**DESIGNED TO MEET THE WORKLOAD
REQUIREMENTS OF THE INDUSTRIES
WE WORK FOR.**







AM Series

REVERSIBLE QUICK-COUPLER

ONLY REVERSIBLE COUPLER AS STRONG AS A PIN-ON

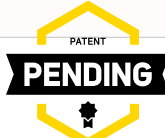

HYDRAULIC AND MECHANICAL COMPATIBLE

- Attaches lower than other brands
- Available in several sizes (holds up to 20 tons)



CUSTOM MADE TO SUIT YOUR NEEDS

- Compact design



PCH Series

QUICK HITCH PIN GRABBER STRUCTURE

MAXIMIZE THE WRENCH POWER AND STRENGTH OF YOUR MACHINE



Available with hydraulic or mechanical systems

Our Pin Grabber is made of heavy duty steel and is available with a hydraulic system and dual safety system in case of hydraulic system pressure failure.

The Pin Grabber is also available with a semi-manual mechanical system and a spring system for an automatic coupling multi-center / center for all attachments.

Dual safety system

Equipped with a manual safety restraint system to ensure safe use on all excavation work.

Available for excavators ranging from 7.5 to 85 tons

HYDRAULIC INSTALLATION KIT

- Hydraulic valve
- Pressure limiting device (2x)
- Electrical assembly
- Audible alarm

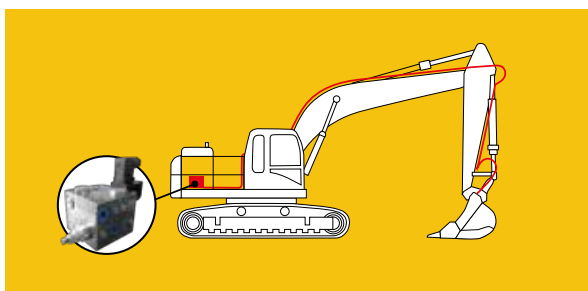



Ai Series

TILTING QUICK-COUPLER

TRANSFORM YOUR STANDARD BUCKET TO A 180° TILTING BUCKET



With cylinders



AVAILABLE IN SEVERAL CONFIGURATIONS

- With any type of quick-coupler

STANDARD

45° inclination on each side.

Tilt 90° and more depending on model



HELAC

Adaptable to all of our equipment or excavators ranging from 3.5 to 40 tons.

360° tilt and rotation



TILTROTATOR

GRYB maximizes the yield of your attachments by combining efficiency, power, and versatility.

Compact design and robust construction allows tilting up to 55°.

Offered in several standard configurations and compatible with any other type of attachment.



AFE Series

STANDARD FEMALE COUPLER

MAXIMIZES THE PERFORMANCE OF YOUR ATTACHMENTS



COMPATIBLE WITH ALL QUICK DISCONNECT FASTENERS AND PIN-ONS.

EASILY ADJUSTABLE TO YOUR BUCKET.

CUSTOMIZED DESIGNS TAILORED TO YOUR NEEDS.

With or without excess under the quick-coupler

Bolted plate also available



AFR Series

FEMALE COUPLER



AFE and AFR models are built with an excess so you can attach them to your buckets by yourself.

GRYB OFFERS NUMEROUS FEMALE COUPLER MODELS COMPATIBLE WITH EVERY TYPE OF FEMALE COUPLER.

Every client is unique and therefore GRYB's research and development department is continuously working towards finding the best solution for each of its clients.





PUB Series

CONCRETE PULVERISER

FASTEST AND STRONGEST ON THE MARKET



Interchangeable female coupler



- A STRONGER JAW THAN THE STANDARD PIN-ON

- TAKES ONLY 5 MINUTES TO INSTALL
(10 X FASTER THAN OTHER BRANDS)

- INTERCHANGEABLE TOP PLATE
(COMPATIBLE WITH ALL TYPES OF EXCAVATORS)

Their elite design can crush, break, or pulverize several types of concrete.

Equipped with interchangeable teeth, their design offers durability and increased crushing power.

Made of heavy-duty steel, they are more resistant to wear than regular steel.

We exclusively offer interchangeable female couplers compatible with all our standard products.

CRUSHING FORCE

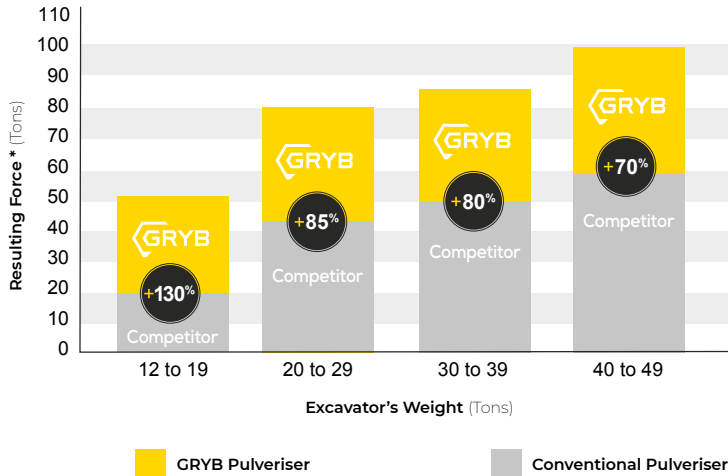

* Crushing power may vary from one coupling model to another. Crushing power can vary depending on material crushed. Please contact us to ensure

Exclusivity

Interchangeable female coupler compatible with your quick-coupler, no modifications required.

Each concrete pulveriser model is compatible with two types of excavators.

**Other models and sizes available on request.

¹ Quoted weight does not include top plate.

² The indicated weights exclude female couplers

³ The indicated weights exclude the top plate

- **Fastest implementation system with best force ratio on the market**
- **Interchangeable bolted-on top plate (compatible with all excavator models)**
- **Compatible with all quick-coupler models**
- **No auxiliary hydraulic needed for the mechanical system; reducing maintenance needs**
- **Strategic teeth positioning reduces splinters to maximize on-site security**



WARRANTY

2
YEARS

GT Series

SCREENING BUCKET

SCREEN ON SITE WITH ONE MACHINE
AND ONE OPERATOR

Adjustable hydraulic wheel motor

HEAVY DUTY FOR ALL TYPES OF WORK

- REVERSIBLE HYDRAULIC WHEEL MOTOR
 - ULTRA DURABLE
 - ADJUSTABLE FROM 12 to 34 RPM
- Decontamination | Rock | Recycling**

7 DIFFERENT MODELS AVAILABLE

(depending on the technical specifications of your machine).

AVAILABLE

Interchangeable bolted mesh as an option from 0.25 in to 12 in. for easy switch on worksite!



Interchangeable bolted screens

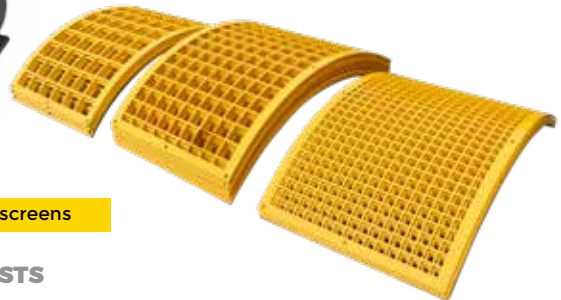

NO MAINTENANCE REQUIRED | STURDY | REDUCES OPERATION COSTS

MADE FOR EXCAVATORS RANGING FROM 3.5 TO 65 TONS.

ALSO AVAILABLE FOR YOUR LOADER

Order our loader compatible coupler so that you can use your screening bucket on your loader!
We aim to offer attachments to satisfy all your needs.



PRODUCTIVITY

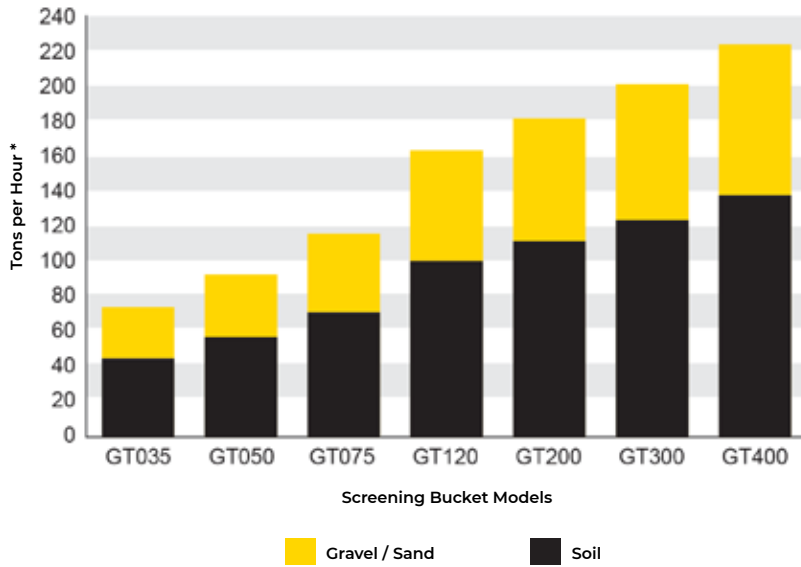

* Subject to change depending on humidity

PERFORMANCE

The performance of our screening buckets varies according to several factors such as screen dimension, soil quality, temperature and machine operator.

The graph to the left estimates the possible performance for each model in ideal conditions.



ALL OF OUR SOLUTIONS ARE ADAPTABLE TO THE MACHINERY AND THE SPECIFIC REQUIREMENTS OF CONTRACTORS IN SEVERAL INDUSTRIES, SUCH AS MINING INDUSTRY.







XHD Series

EXTREME HEAVY-DUTY BUCKET

IDEAL FOR USE WITH TERRAIN THAT HAS BEEN MINED OR BLASTED



SAFETY FACTOR 4X THE MAXIMUM STRENGTH OF THE EXCAVATOR.

LOADING AND DUMPING AT OPTIMIZED ANGLES.

RECOMMENDED CHOICE IF YOU CHANGE YOUR TEETH EVERY 200 HOURS.

AVAILABLE FOR EXCAVATORS RANGING FROM 20 TO 120 TONS.

- Easily interchangeable bolted-on wear plates
- Wear plates are added on the backing and side boards to prevent premature wear
- The half-arrow edge is 100 %protected
- Heel shrouds will protect your bucket welds from abrasion and premature wear
- The V-shaped blade makes penetrating blasted materials easy

These buckets are designed for the worst winter and mining conditions.

- Manufactured from extremely wear-resistant materials and are assembled with great precision.
- Our XHD buckets are subject to several quality tests and are approved by an engineer.





G4P Series

4-IN-1 BUCKET

COMBINES THE USE OF A GRAPPLE, THE STRENGTH OF A STANDARD THUMB, AND THE FUNCTIONS OF A DITCHING BUCKET



- COMPACT AND VERSATILE DESIGN
- ELIMINATE MAINTENANCE PROBLEMS
- 45° INCLINATION ON EACH SIDE

AVAILABLE FOR EXCAVATORS RANGING FROM 3.5 TO 40 TONS.

- Better precision and control
- Maximizes the efficiency of your attachment
- Improves safety on construction sites
- Increases machine productivity and versatility

PROPOSED COMBINATION WITH TILTING QUICK-COUPLER

- 45° inclination on each side
- Maximizes the efficiency of your attachment
- Available for all types of quick-couplers

EASILY SWITCH BETWEEN LEVELING, HANDLING, DIGGING, AND EXCAVATING.





GPT Series

TILT DITCHING BUCKET

45° TILT ON EACH SIDE

-SUPERIOR DESIGN, 45° TILT ALLOWS MOVEMENT ON EACH SIDE.

-SAVES TIME AND MONEY FOR THE OPERATOR.

-AVAILABLE IN DIFFERENT SIZES AND CAPACITIES FOR DIFFERENT TYPES OF WORK AND EXCAVATORS.

AVAILABLE IN 2 OPTIONS:

- WITH CYLINDERS
- WITH HELICAL ROTATION (HELAC)

- HYDRAULIC CYLINDERS WITH TOTAL PROTECTION FROM DEBRIS
- HARDENED CHROME-PLATE AXLE WITH GREASEABLE WEARING RINGS
- AVAILABLE IN MULTIPLE DIMENSIONS AND CAPACITIES FOR DIFFERENT TYPES OF WORKS AND EXCAVATORS

AVAILABLE FOR EXCAVATORS RANGING FROM 3.5 TO 40 TONS.

Interchangeable female coupler

Hardened chrome plate

Interchangeable bolted blade optional





GPF Series

DITCHING BUCKET

FILLING AND DUMPING AT OPTIMIZED ANGLE



BUILT SOLID

GRYB ditch buckets are built with solid and resistant steel, allowing you to work with great precision. Available in different sizes and capacities for different types of work and excavators.



- Filling and dumping at optimized angle
- Reversible quick-coupler available up to 15 tons
- For excavators ranging from 1.5 to 40 tons





GSF | GSD Series

SKELETON BUCKET

IDEAL FOR RECYCLING MATERIALS



BUCKET MADE OF HEAVY-DUTY STEEL EXTENDED WEAR RESISTANCE

MAINLY DESIGNED FOR EXCAVATION AND DITCHES.

- Space between plates can be customized from 1 in to 24 in based on your needs
- General purpose model also available
- For excavators ranging from 12 to 40 tons
- Optional: interchangeable bolted cutting edge
- Optional: interchangeable bolted teeth



Custom made to suit your needs

Spacing for the fork opening from 1 in to 24 in



GPV Series

TRAPEZOIDAL BUCKET

PERFECT FOR TRENCH DIGGING



- Saves time
- 45° cutting edge angle
- Optional: interchangeable teeth
- For excavators ranging from 3.5 to 40 tons

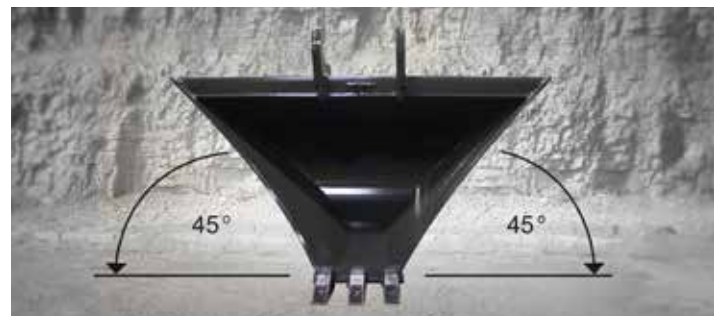



GRD Series

RECESSED BUCKET

TO OPTIMIZE FORCE

NEW!



The **GRYB Recessed Bucket** combined with a standard Pin Grabber provides excavation power equal to the original bucket thanks to its exclusive shape, which respects the conventional excavator tilting radius.

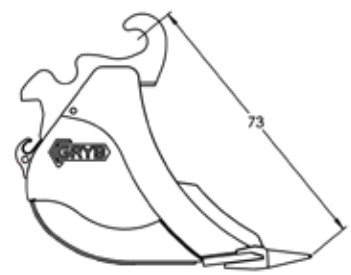
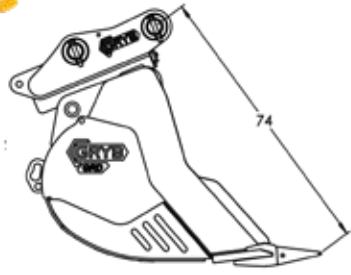

PEI Series

ROOT RAKE

IDEAL FOR CLEARING AGRICULTURAL OR WOODED LAND

The curvature makes extraction and handling a breeze. Whether it's clearing farmland or forests, nothing can stop it.

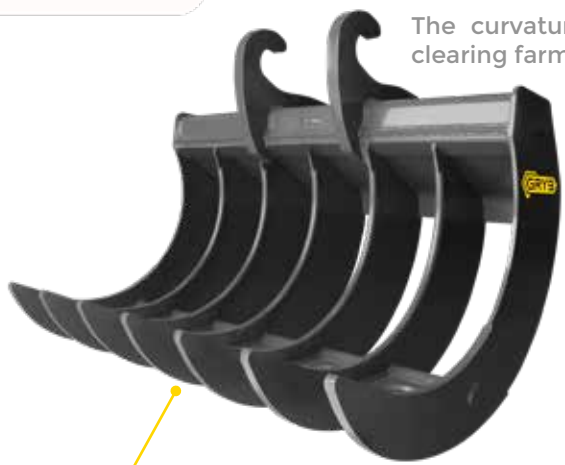

- Extra heavy-duty steel design
- Available in different sizes for different types of work

PROPOSED COMBINATION

A grapple or a thumb can be added to your rake.

This combination will assist you during your material handling situations. It is the needed helping hand to speed up work.

Interchangeable teeth optional



- CHOICE OF INTER-FINGERS SPACE
- CHOOSE THE NUMBER OF FINGERS
- ANTI-TRAPPING SYSTEM INCLUDED



RIP Series

RIPPER



THE ARCHED SECTION ALLOWS FOR EASY PENETRATION OF ROCKY AND FROZEN GROUND



Bolted-on interchangeable tooth

- Made of heavy duty steel
- Offers a superior digging force and a leverage effect
- Available in different sizes for different types of work and excavators

- INTERCHANGEABLE BOLT-ON TOOTH
- MINIMAL MAINTENANCE
- FOR EXCAVATORS RANGING FROM 1.5 TO 85 TONS



STS Series

STUMP SHEARS



IDEAL FOR CLEARING FARMLAND OR FORESTS



Female bolted and interchangeable quick-coupler

2 interchangeable cutting edges

Bolted-on interchangeable teeth

INNOVATIVE DESIGN

Allows you to perform long range jobs thanks to the ideal shape and angle of clearance of the removable part.

For excavators ranging from 1.5 to 40 tons.

- 2 X STRONGER THAN THAT OF THE COMPETITION
- BUILT OF EXTRA HEAVY-DUTY STEEL
- NOTHING STANDS IN THE WAY OF OUR ROOT RAKE!
- MECHANICAL ARM AND SUPPORT INCLUDED



POB Series



HYDRAULIC THUMB ON AXLE SUPPORT

FACILITATES MOVING LARGE OBJECTS OR SETTING DOWN ITEMS IN SPECIFIC PLACES



- CHOICE OF 2-4 FINGERS
- OUR IMPROVED DESIGN ALLOWS YOU TO MAINTAIN GOOD VISIBILITY
- 135° ROTATION, LOCKED VALVE INCLUDED

Fixed on the axle support, this thumb design follows the rotation of your bucket and allows maximum yield when performing your work.

Available in different sizes, for any type of excavator. **FOR EXCAVATORS RANGING FROM 1.5 TO 40 TONS**

XHD HYDRAULIC CYLINDER

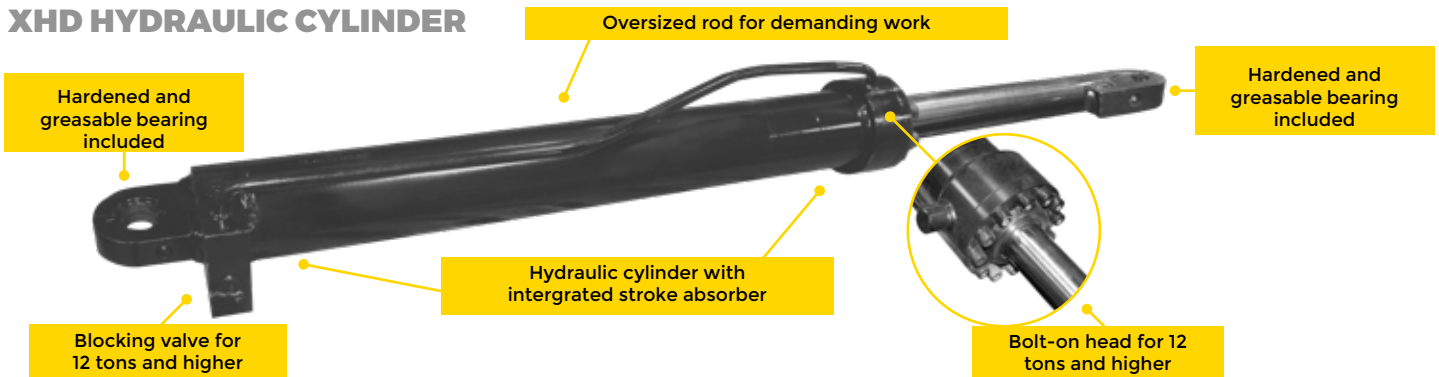

HYDRAULIC THUMB ON AXLE SUPPORT POB SERIES



PROGRESSIVE THUMB PPB SERIES



UNIVERSAL EXTENSIBLE HYDRAULIC THUMB POG SERIES





AL Series

QUICK-COUPLER



DESIGNED TO OFFER MAXIMUM VISIBILITY AND EASY CHANGE OF ACCESSORIES

HIGH-RESISTANCE HYDRAULIC CYLINDERS WITH ALL-ROUND PROTECTION

- Designed to offer maximum visibility and easy change of accessories.

- Made of heavy-duty steel and assembled with great precision, these products offer outstanding reliability and quality.

We manufacture all quick-hitch models.

High-strength steel

Assembled with great precision



COMPATIBILITY

Compatible with all female couplers and all loader models.



COMPATIBLE JRB



COMPATIBLE CATERPILLAR



COMPATIBLE VOLVO



AFL Series

FEMALE COUPLERS



STURDY AND DESIGNED TO MAXIMIZE YOUR BUCKET'S PERFORMANCE

- WITH EXCESS FOR ALL BUCKETS AND CARRIAGE MODELS
- COMPATIBLE WITH ALL MANUFACTURER'S QUICK-COULPLERS
- DESIGNED TO MAXIMIZE YOUR BUCKET'S PERFORMANCE

CUSTOM DESIGN

We produce all female coupler models compatible with the manufacturer's quick-couplers.

Specify your exact model and we will provide you with the required coupler.



COMPATIBLE JRB

REPLACEMENT SERVICE

Mention your specific model and we will be able to produce the fitting for your equipment.



COMPATIBLE CATERPILLAR



COMPATIBLE EDF



COMPATIBLE VOLVO



GLH Series

EXTREME-USE ROCK BUCKET

WEAR RESISTANT FOR WORK ON ROCKY OR
BLASTED TERRAINS



QUALITY CONTROL

Our Extreme-Use Rock Buckets are subject to several quality tests and are approved by an engineer.

Each part is preheated to the recommended temperature and then welded in a controlled heat to provide outstanding resistance.

- OPTIONAL INTERCHANGEABLE BOLTED CUTTING EDGE
- OPTIONAL INTER-TEETH TO PREVENT BLADE WEAR
- INTERCHANGEABLE AND BOLTED WEAR-PLATES

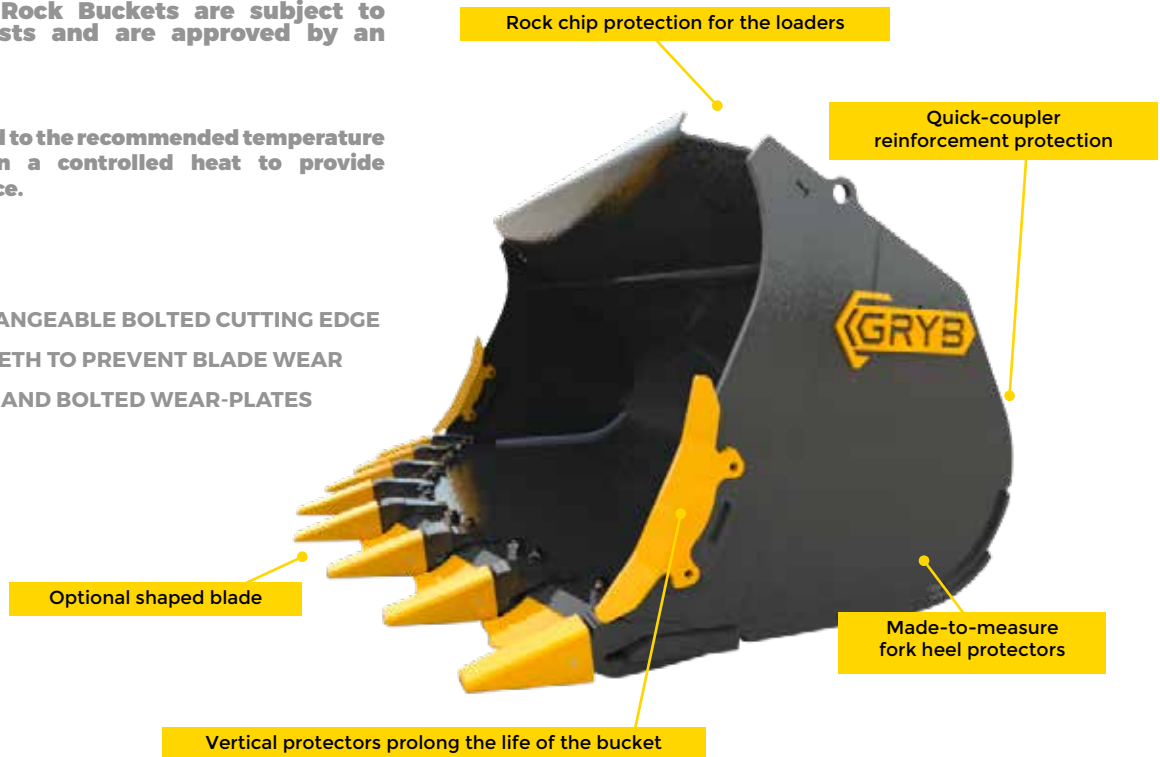



GLI Series

HIGH DUMP BUCKET



IDEAL FOR LIGHT MATERIALS SUCH AS WOODCHIPS, SAND, ETC.

- **OVERSIZED ROD FOR INTENSIVE WORK**
- **DUMP ANGLE UP TO 120°**
- **HIGH CAPACITY**

COMPLETE TOOL

This bucket is the most versatile attachment for light and multi-purpose work.

It boasts two hydraulic cylinders, enabling 120° of effortless release.

Damping pads are installed to minimize impact on return to the working position.



HD hydraulic cylinder

Bolted and interchangeable blade optional

Damping pads





GLL Series

LIGHT-MATERIALS BUCKET



IDEAL FOR LOADING LIGHT MATERIALS
SUCH AS SNOW, WOODCHIPS, ETC.

- PROVIDES GOOD VISIBILITY

- OPTIMAL FOR SNOW REMOVAL OR LIGHT MATERIALS

- WIDE RANGE OF BUCKETS

GRYB's wide range of buckets will exceed your expectations. If it is for normal use, a better lifting capacity when working with light materials, or to improve your work in rocky and blasted terrain, these buckets are designed to offer superior functionality and durability. If you want to remove or add specific pieces to your equipment, our team will assist you and create, with your help, the best possible performance tools.

Quick-disconnect fastener compatible with all types of quick-hitches



Interchangeable bolt-on blade included

Fork-heel protectors





**GENERAL-PURPOSE
BUCKET GLG SERIES**



COMBINATION

Complete your snow removal work more quickly and efficiently by adding a snow pusher.





GLD Series

SIDE-DUMP BUCKET



WEAR RESISTANT FOR WORK IN ROCKY OR BLASTED TERRAINS

- DUMPING ANGLE UP TO 70°
- OVERSIZED ROD FOR DEMANDING WORK
- SEQUENTIAL HYDRAULIC DISTRIBUTOR

FOR A SAFE WORK ENVIRONMENT

This bucket simplifies loading trucks in places where access is too small for a conventional loader.

Side-Dump Buckets are equipped with a security system, and sequential automatic release distributor for the locking device when dumping and locking back up in order to ensure a safe work environment at all times.

HD Hydraulic cylinder



Optional: Bolted blade





GLP Series

GRAPPLE BUCKET



PRECISION HANDLING FOR YOUR DEMOLITION WORK

- **LOADING AND DUMPING AT OPTIMIZED ANGLES**
- **THE WIDEST SECTION OF THE GRAPPLE RELEASES THE BLADE**
- **OVERSIZED ROD FOR INTENSIVE WORKLOADS**

ROBUST DESIGN

Compatible with all types of quick hitches

HD Hydraulic cylinder



Optional: Bolted-on blade

This bucket was conceived and designed with two grapples to offer a robust product for your professional needs.

The pronounced curvature of these two grapples allows precision handling for your demolition work.

They are an asset for the transportation of construction materials.





GLX Series

SKELETON BUCKET

IDEAL FOR SORTING AND RECYCLING MATERIALS



FOR BACKHOE LOADERS AND WHEEL LOADERS

- CUSTOM MADE TO SUIT YOUR NEEDS
- SPACING BETWEEN FORKS AVAILABLE IN INCREMENTS OF 1 IN TO 24 IN



Size of adjustable holes

Optional: Bolted and interchangeable blade

PROPOSED COMBINATION

COMBINING OUR SKELETON BUCKET AND GRAPPLES GIVES YOU THE VERSATILITY OF TWO ATTACHMENTS IN ONE FOR YOUR SORTING NEEDS.

THE BUCKET CAPACITY WILL ALSO BE DECOUPLED.





FL Series

UNDERCARRIAGE

FOR ALL YOUR LIFTING AND HANDLING REQUIREMENTS



- **STURDY CONSTRUCTION**
- **FORKS ON A SIDE SHIFT AXIS**
- **DESIGN OFFERS OPTIMAL VISIBILITY**

- Compatible with hydraulic and mechanical systems
- Various forks available
- Wide variety of models and several sizes available

PROPOSED COMBINATION

Equip your undercarriage with grapples to enhance your handling precision.

With its ease of handling, you're sure to love this combination instantly!



Optional: Top protector

Various fork options available

Hydraulic and/or mechanical systems

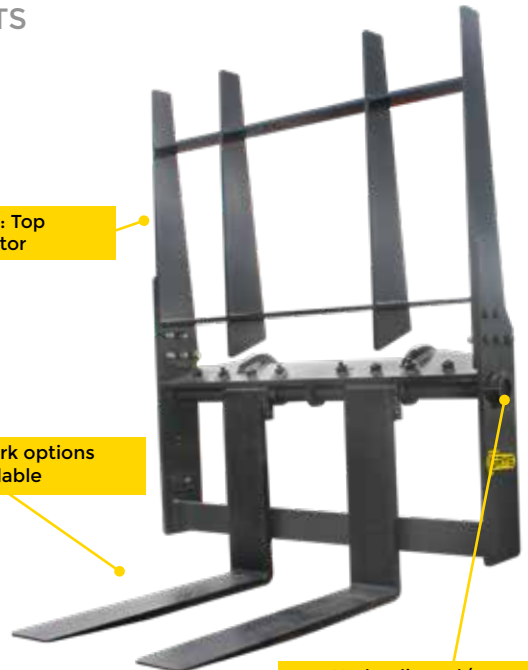

UNDERCARRIAGE WITH FORK ON AXIS
(12,600 lb AND MORE)



UNDERCARRIAGE WITH FORK IFA
(21,600 lb AND LESS)





LBM Series

JIB BOOM



WARRANTY

2
YEARS

EXTENDIBLE ARM FOR HARD-TO-REACH AREAS

- INCREASES CONSTRUCTION SITE SECURITY
- OPTIMIZED DESIGN OFFERING VISIBILITY AND SAFETY IN COMPARISON TO LIFT ATTACHMENTS
- GROWING DEMAND FOR THESE PRODUCTS FOLLOWING NEW GOVERNMENT CERTIFICATION (CSST, UNIONS, CITIES, HYDRO-QUEBEC, ETC.)

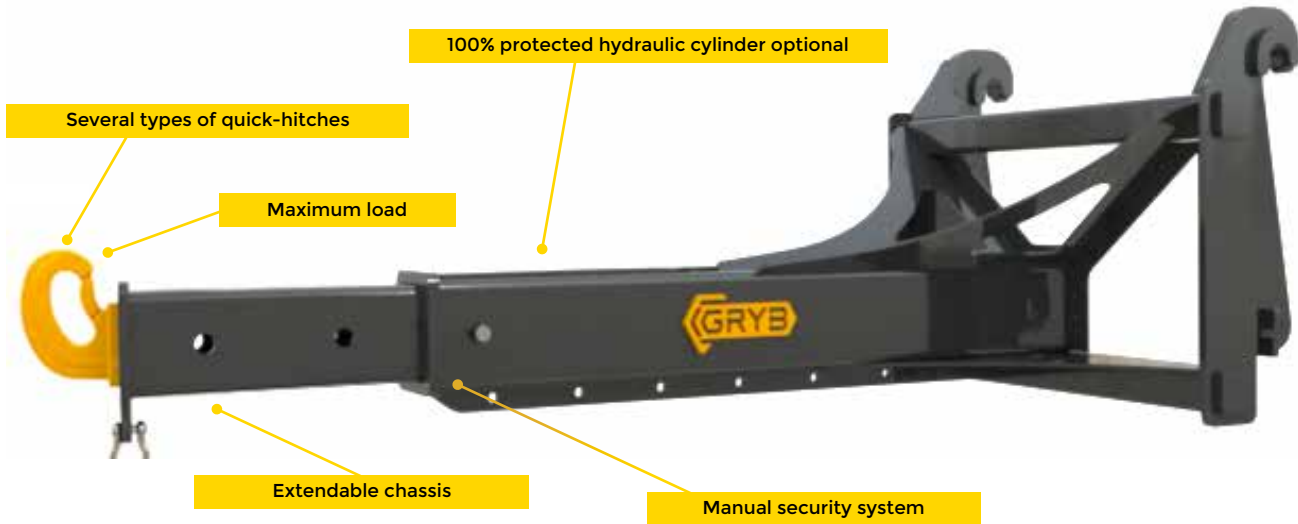

LIFTING CHART INCLUDED

All our Jib Booms come with an engineer-certified lifting chart.

Optimized design offering visibility and safety in comparison to lift attachments.

Growing demand for these products following new government certification (CSST, unions, cities, Hydro-Quebec, etc).

TYPES OF QUICK-HITCHES AVAILABLE

- Trailer hitch
- Standard hook
- Pejo hook
- Shackle





BlueGRYB™

BC Series

ROTATING ICEBREAKER

CRUSHES ICE QUICKLY AND EFFICIENTLY



WARRANTY

2 YEARS

3 X FASTER THAN STANDARD ICEBREAKING OPERATIONS, EVEN AT VERY LOW TEMPERATURES.

UNIQUELY-ANGLED HELIX DESIGN FEATURES A 7-TOOTH SERRATED ROLLER INSTALLED EVERY HALF INCH TO AVOID MARKING GROUND.

- CRUSHES ICE UP TO 2 IN THICK
- AUTOMATICALLY ADAPTS TO GROUND LEVELLING



Interchangeable bolted-on teeth

Unique angled helix design features a 7-tooth

Rubber shock absorbers

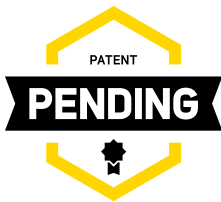

Interchangeable bolt-on teeth assemblies

25.75" O.D.

3-Row Teeth Assembly

28-Teeth per Row = 84 Teeth per hub Assembly

Teeth Retainer Hub Assembly



IDEAL FOR:

- SIDEWALKS
- ROADS
- PARKING

BlueGRYB^{MC}

SEVERAL WIDTHS

Ranging from 41 in to 103 in



- Breaks ice up to 2 in thick
- Operation speed between 25 and 40 km / h
- Abrasive and melting material reduction (green solution)
- Interchangeable teeth bolted on by section to minimize maintenance costs
- Uniquely-angled helix design features a 7-tooth serrated roller installed at every half inch to avoid marking the ground
- Rubber dampers for shock absorption





S Series

DIRECTIONAL SNOW PUSHER

PERFECT FOR CLEARING SNOW FROM PUBLIC ROADS



- DIRECTIONAL BLADE
- AUTOMATIC GROUND LEVELING AND SWIVELING
- SHOCK-ABSORBER SYSTEM
- BOLT-ON LATERAL SIDES

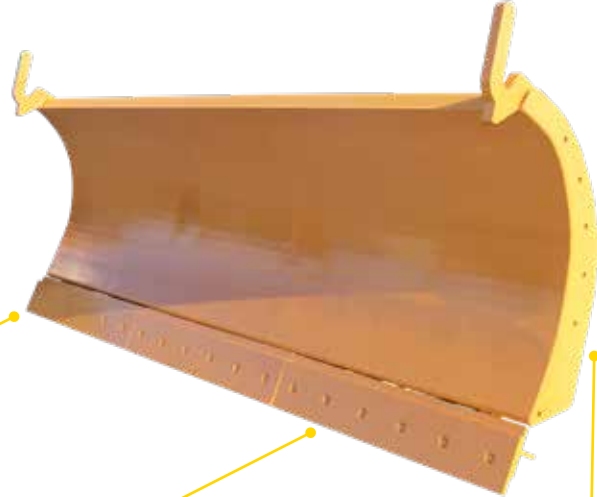

Shock-absorber system

Several types of blade available

Swiveling, mechanical or hydraulic lateral sides

PROPOSED COMBINATION

Combine your snow pusher with an optional extension to maximize your snow-clearing operations.

Available in different sizes.





S Series

REVERSIBLE SNOW PUSHER



WARRANTY

2
YEARS

SEVERAL MODELS AND DIMENSIONS AVAILABLE

- Open pusher
- Sealed pusher with retraction blade
- Open pusher with retraction blade

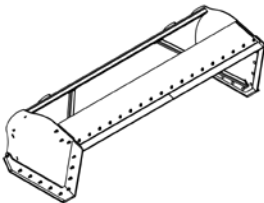
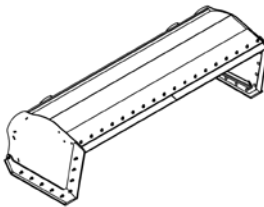
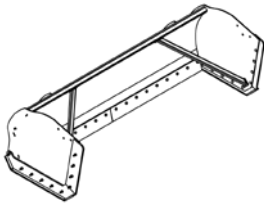

Snow pushers with pivoting panels are guaranteed for a maximum of one year.

- **DIFFERENT CHOICE OF BLADES**
(TEFLON, HIGH-RESISTANCE STEEL, OR ICEBREAKER)

- **WELDED SIDE PANELS**
(DIFFERENT LENGTHS AVAILABLE)

- **OPTIONAL TOP RETRACTION BLADE**





GLGB | GLLB | GLDB | FLB | ALB | ALB-SM Series



FRONT END ATTACHMENTS

IDEAL FOR MULTI-TASKING

WE MANUFACTURE ALL BACKHOE ATTACHEMENTS

GENERAL-PURPOSE BUCKET
GLGB Series



LIGHT-MATERIALS BUCKET
GLLB Series

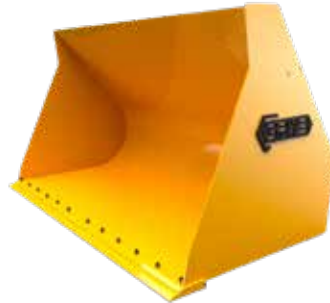

SIDE-DUMP BUCKET
GLDB Series



UNDERCARRIAGE
FLB Series



QUICK-COUPLER "580 STYLE"
ALB Series



QUICK-COUPLER
ALB-SM Series



CUSTOM-MADE TO SUIT YOUR NEEDS

OUR SERIES PRODUCTS ARE DEVELOPED IN ORDER TO OFFER SIMPLE AND EASY ADAPTABILITY TO YOUR BACKHOES.





LARGE RANGE OF FRONT BUCKETS

GRYB's wide range of buckets will exceed your expectations.

If for normal use, a better lifting capacity when working with light materials, or to improve your work in rocky and blasted terrains, these buckets are designed to offer superior functionality and durability. If you want to remove or add specific pieces to your equipment, our team will assist you and create, with your help, the best possible performance tools.



UNDERCARRIAGE

Its sturdy construction, which features forks on the side-shift axles will solve all your lifting and handling needs.

Its design offers optimal visibility.





GBE | PGH | HELAC | AMM | AMH | PBB | PBE Series



BACKHOE ATTACHMENTS

IDEAL FOR MULTITASKING

WE MANUFACTURE ALL BACKHOE ATTACHMENTS



LARGE RANGE OF THUMBS

GRYB's wide range of thumbs will ease your work, no matter what it is.

Each of our hydraulic thumbs (fixed axle support, extensible, or "progressive" option) has its own specifications to facilitate moving large objects or setting down items in specific places.

Our improved designs allow you to maintain good visibility.



PIN GRABBER STYLE QUICK-COUPLER

Our Pin Grabber is made of heavy-duty steel and is available with a hydraulic system and two safety systems in case of hydraulic pressure failure.

It is also available with a semi-manual mechanical system and spring system for an automatic coupling multi-center / center for all your attachments. It is also equipped with a manual safety restraint system ensuring safe use on all your excavation work.



CUSTOM-MADE TO SUIT YOUR NEEDS

OUR PRODUCTS ARE DEVELOPED TO
OFFER SIMPLE AND EASY ADAPTABILITY
TO YOUR BACKHOES.

TEETH BUCKET
GBE Series



**"HELAC"
STYLE
QUICK-COUPLER**



**EXTENDABLE
HYDRAULIC THUMB**
PBE Series



**HYDRAULIC THUMB
ON AXLE SUPPORT**
PBB Series



**MECANICAL OR HYDRAULIC
QUICK-COUPLER**
AMM & AMH Series



MAGNETICS

DIVISION \GRYB



RAILWAYS



RECYCLING



SEPARATION



HANDLING



MINING INDUSTRIES



The MAGNETICS division specializes in the creation and manufacture of magnets and electromagnets that are specially designed to increase productivity and facilitate work in each of the industries we work with. We offer solutions for handling, cleaning, separation, etc.

All solutions are perfectly adaptable to the machinery and the specific requirements of contractors, as well as the numerous custom projects for which we are known.





PC Series

SCRAP MAGNET

POWERGRIP

SORTING, CLEANING AND HANDLING FOR SCRAP YARD

DEEP-FIELD DESIGN

- HEAVY-DUTY STEEL CASING
- OFFERS AN EXCEPTIONAL CAPACITY-WEIGHT RATIO
- PERFECT COMBINATION WITH A GRAPPLE
- Standard size from 36", 40", 48", 57" and 63" available at all times
- Custom design available
- Aluminum coil
- H-class insulation



AVAILABLE ATTACHMENTS

- Dangling female coupler
- Rigid female coupler for magnets
- Universal attachment for grapples
- Chains (included)
- Special attachments available on request
- Optional teeth system available (ideal with top plate)





POWERGRIP MAGNETS

PowerGrip magnets are designed and manufactured following the highest industry standards to meet the growing demands of the market.

The competitive price and light weight of these magnets makes them an excellent choice to perform your daily tasks in the scrapyards and will complement other equipment such as grapples.





XG Series

SCRAP MAGNET XTREMGRIP

HANDLING AND LOADING FOR SCRAPYARD, STEEL PLANT,
AND PORT OPERATIONS

EXTRA DEEP-FIELD DESIGN

Depending on the application, several sizes are available, between 68" and 96".

- **ROBUST FABRICATED STEEL CASING**
- **IDEAL FOR SEVERE-DUTY OPERATIONS**
- **H-CLASS INSULATION**

- **Optimized power-weight ratio**
- **Optional teeth system available**
(Ideal with top plate)
- **Increased performance**
- **Greater lifting capacity**
- **Heavy-duty chains and cables included**

Robust design

HD wire included

Chain included

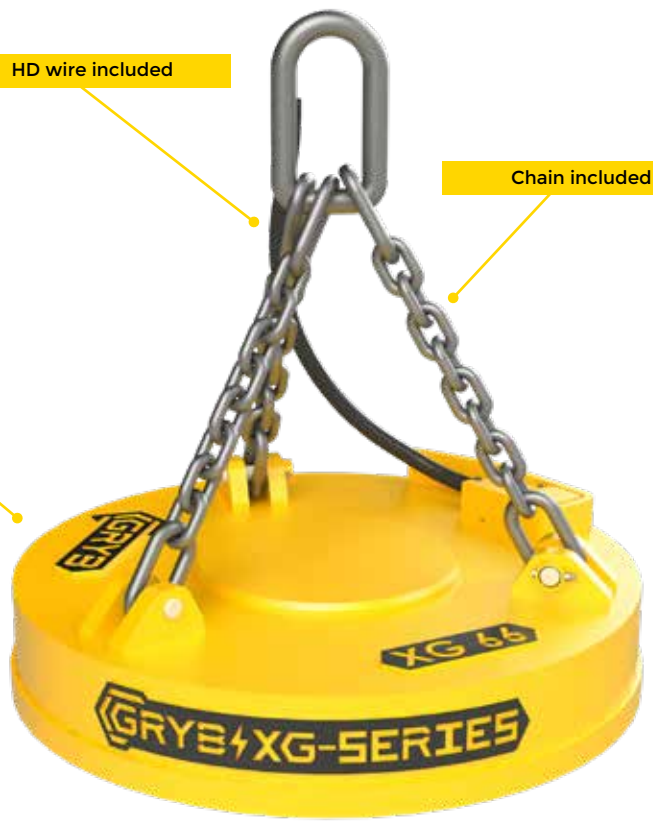



XTREMGRIP MAGNETS

Ideal for intensive loading and unloading of scrap metal, for handling works, for steelworks, as well as for port operations.

They are designed and manufactured for severe-duty operations in handling scrap metal.

The deep-field and robust design makes these magnets very powerful and durable.

AVAILABLE ATTACHMENTS

- Dangling female coupler
- Rigid female coupler for magnets
- Chains
- Custom attachments available on request





HYDMAG Series

HYDRAULIC MAGNET

PERFECT FOR YOUR DEMOLITION PROJECTS



Several types of attachments available



Built with XG or PG magnet



EASY TO INSTALL

EASY TO SWITCH FROM ONE MACHINE TO ANOTHER, ONE MAGNET IS NOT DEDICATED TO ONLY ONE MACHINE.

OPTIONAL FAST WIRELESS OR SOLID WIRE DEMAGNETISATION.

INDEPENDANT SYSTEM

HYDMAG magnets are an important asset to any demolition equipment fleet. This unit is completely independent.

The generator is installed directly onto the magnet. Once the hydraulic hoses are connected to the excavator, you are ready to work.

The optional DMAG allows for a quick demagnetisation of the magnet.



BM Series

BATTERY MAGNET

PERFECT FOR LIGHT SCRAP METAL HANDLING DUTIES



- NO GENERATOR NEEDED
- EASILY ADAPTED TO YOUR MACHINE
- MAGNETS OF 28 IN AND 48 IN CAN BE USED WITH 12 V OR 24 V WITHOUT A LOSS OF STRENGTH
- POWERED BY YOUR EQUIPMENT BATTERIES
- IDEAL FOR RAILWAY REPAIR OPERATIONS

Several types of attachments available

- HMI included
- Chains included
- 80 or 100-amp controller
- Operator control with pedal



AVAILABLE OPTIONS

- Joystick
- Extra controller for multiple equipments
- Battery pack
- Conversion from 12 V to 24 V
- Several types of attachments
- Teeth solution

Due to their ease of installation, our magnets can be installed on various machines by simply adding a controller to the equipment.



MH Series

HANDLING MAGNETS

SECURES, FACILITATES, AND DECREASES HANDLING PROCESSES



COMPLETE TAILORED SOLUTIONS

- COPPER OR ALUMINUM WOUND MAGNET AS REQUIRED
- INSTALLATION ON MOUNTING BRIDGE, FORKLIFT, OR ANY OTHER HANDLING MACHINE

INTELLIGENT CONTROLLERS

Controls are state-of-the-art with intelligent controllers linked to an HMI screen.

It is also possible to know the weight of the load lifted by each magnet in real time.





- Complete engineering service
- Hot work design available
- Controller and battery backup management
- Electro-permanent magnets
- Magnet improvement
- Magnet repair

CUSTOM DESIGN

GRYB MAGNETICS has the expertise to manufacture steel handling magnets in various forms, tailored to your needs.

GRYB's strength lies in its innovative features as well as its creativity to meet the needs of clients.

Whether you're handling plates, loads of tubes, load of rods, rollers, or any other steel product, we have the solution.

CPMAG Series



PERMANENT MAGNETIC SEPARATOR CONTINUOUS CLEANING

THE CPMAG SERIES IS THE MOST ECONOMICAL IN TERMS OF SELF-CLEANING SEPARATORS.

CPMAG series is designed for intensive use and for handling a high volume of materials.

Easy to use, the separator requires almost no maintenance and can capture all sizes of ferrous particles at a moderate distance.

SUSPENSION HEIGHT UP TO 12"

AVAILABLE OPTIONS

- OVERSIZED COMPONENTS
- MANY BELT OPTIONS
- SEVERE SERVICE
- HYDRAULIC MOTORIZATION
- WEAR PLATE
- CHOICE OF MOTOR VOLTAGE

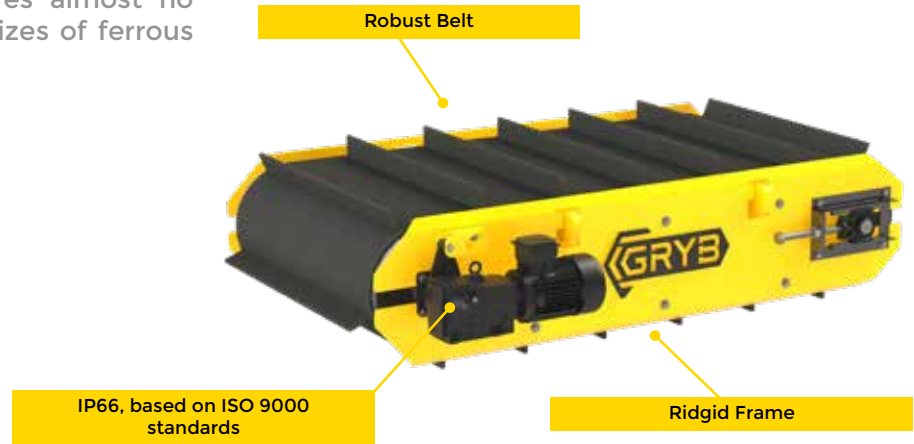

PMAC Series



PERMANENT MAGNETIC SEPARATOR MANUAL CLEANING

IDEAL FOR MINES, AGGREGATES, CRUSHED STONE, WOOD MILLS, MRF, STEEL SHREDDERS, USED SOIL PROCESSING, AND FOUNDRIES

Ideal for protecting equipment and handling low volumes of iron.

- NO OPERATING COST
- NO DC POWER REQUIRED
- MAINTENANCE FREE
- SUSPENSION HEIGHT UP TO 12"

AVAILABLE OPTIONS

- WEAR PLATE
- CLEANING SYSTEM



CEMAG Series



ELECTROMAGNETIC SEPARATOR CONTINUOUS CLEANING

THE CEMAG SERIES IS THE MOST EFFICIENT IN TERMS OF SELF-CLEANING SEPARATORS.

- ALUMINUM WINDING WITH HIGH QUALITY NOMEX INSULATION
- WIDE RANGE OF AVAILABLE POWER: 3 KW TO 45KW
- BELT WITH 2 INCH CLEATS (OTHER OPTIONS AVAILABLE)
- OIL COOLED WITH EXPANSION TANK
- DIRECT DRIVE CLASS II MOTOR
- HEAVY-DUTY STEEL CASE
- 100% DUTY CYCLE

AVAILABLE OPTIONS

- MANY BELT OPTIONS
- WEAR PLATES
- SPECIFIC MOTOR BRANDS AVAILABLE ON REQUEST
- BELT PRESENCE DETECTION
- HYDRAULIC MOTORIZATION
- CHOICE OF INPUT VOLTAGE
- 100 VDC OR 230 VDC OUTPUT VOLTAGE
- OVERSIZED COMPONENTS FOR MINING APPLICATIONS

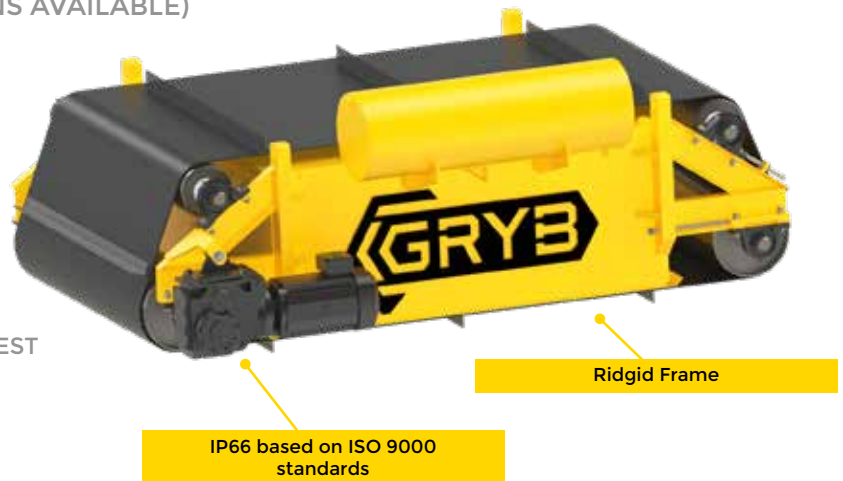

EMAG Series



ELECTROMAGNETIC SEPARATOR MANUAL CLEANING

Featuring a machine-off cleaning mode, the EMAG series is designed to handle small volumes of iron.

- ALUMINUM WINDING WITH HIGH QUALITY NOMEX INSULATION
- WIDE RANGE OF AVAILABLE POWER: 3 KW TO 45KW
- HEAVY DUTY STEEL CASE
- 100% DUTY CYCLE

AVAILABLE OPTIONS

- WEAR PLATES
- 100 VDC OR 230 VDC OUTPUT VOLTAGE
- CHOICE OF INPUT VOLTAGE



POMAG Series



PERMANENT MAGNETIC PULLEY

MAGNETIC PULLEYS ARE INSTALLED ON NEW OR EXISTING CONVEYORS TO TRANSFORM THEM INTO SELF-CLEANING SEPARATORS. OPTIONAL DEFLECTOR AVAILABLE TO COMPLETE THE SYSTEM.

- RESISTANT STAINLESS STEEL ENCLOSURE
- 100% DUTY CYCLE
- CONTINUOUS MAGNETIC FIELD
- NO OPERATING COST
- CUSTOM SHAFT DIMENSIONS
- MAINTENANCE FREE
- DIAMETER CAN BE CONFIGURED UP TO 48 IN.
- LENGTH CAN BE CONFIGURED UP TO 96 IN.
- EXCELLENT RETURN ON INVESTMENT
- AVAILABLE IN RARE EARTH MAGNET CONFIGURATION FOR EVEN MORE POWER



DMAC Series



PERMANENT MAGNETIC DRUM

GRYB'S MAGNETIC DRUMS ARE DESIGNED TO SEPARATE HIGH CONTENT OF FERROUS MATERIALS FROM NON-FERROUS MATERIALS. DRUMS ARE DESIGNED TO PROCESS HIGH VOLUMES OF MATERIALS WITH MINIMAL MAINTENANCE.

“DEEP FIELD” DESIGN

- LOW OPERATING COST
- CUSTOM DIMENSIONS
- 100% DUTY CYCLE
- RARE EARTH MAGNET
- LENGTH CAN BE CONFIGURED UP TO 96 IN.
- DIAMETER CAN BE CONFIGURED UP TO 36 IN.
- MANGANESE WEAR PLATES
- EXCELLENT RETURN ON INVESTMENT
- CUSTOM SHAFT DIMENSIONS

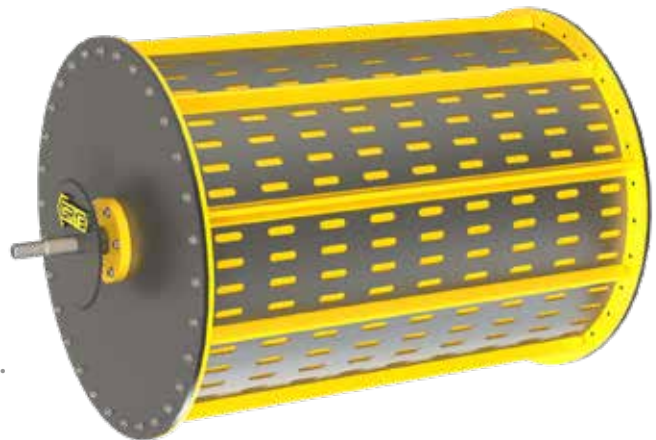

PERMANENT MAGNETIC SWEEPER

IDEAL FOR FACTORIES, AIRPORTS, MINES, SAWMILLS, AND SORTING CENTERS.

THE AIB SERIES IS BUILT TO CLEAN WORK AREAS.

EASY TO USE, THE SWEEPER REQUIRES NO MAINTENANCE AND CAN CATCH ALL SIZES OF FERROUS PARTICULES AT AN IMPRESSIVE DISTANCE, PREVENTING DAMAGE TO VEHICLES AND TO WORKERS.



- RESISTANT STEEL ENCLOSURE
- 100% DUTY CYCLE
- NO OPERATING COST
- STAINLESS STEEL CLEANING SYSTEM
- SUSPENSION HEIGHT: 4"-6"
- NO ELECTRICAL MAINTENANCE
- OPERATING SPEED : UP TO 18 MPH
- REMOVES UNDESIRABLE TRAMP METAL FROM WORK AREAS
- PREVENTS DAMAGE TO VEHICLES
- IMPROVES WORKPLACE SAFETY
- TOWING OPTION AVAILABLE
- CUSTOM WIDTH

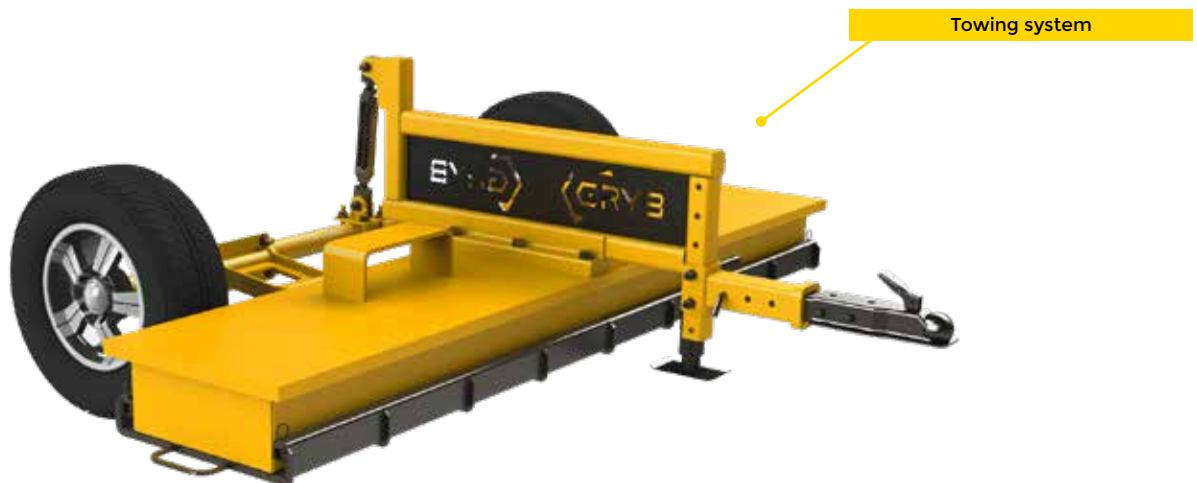

HYDRAULIC GENERATOR

This generator, equipped with a controller, is designed to be very compact. The available hydraulic power potential on the machine provides the power to operate the electromagnet.

A dedicated pump for the generator is installed on the machine to avoid flow fluctuations, function downturn, and uneven traction problems. These issues are observed when a priority valve is being used. The controller allows for rapid magnetization and demagnetisation of the electromagnet.

INTELLIGENT CONTROLLER

WE ALSO OFFER A HIGH-PERFORMANCE INTELLIGENT CONTROLLER FOR GENERATORS TO REPLACE THE OUTDATED MECHANICAL CONTROLLERS.

- SAFE AND COMPACT
- DEDICATED PUMP FOR GENERATOR
- CONTROL VALVE FOR GENERATOR (USE ONLY WHEN NEEDED)
- ALL INSTALLATION CABLES
- HYDRAULIC PISTON MOTOR
- FOOT SWITCH INCLUDED

CUSTOMIZED PROGRAMMING

(6 DEFAULT MAGNETIZATION MODES)

- EQUIPMENT FAILURE DETECTION
- HMI FOR LIVE VISUALIZATION OF EQUIPMENT PERFORMANCE
- AVAILABLE IN 9, 15, 20, AND 30 KW



DGEN Series

DIESEL GENERATOR

WARRANTY

1
YEAR

The Bateman Engine Drive Magnet Generator comes fully assembled and ready for installation on your machine.

INSTALLATION KIT INCLUDES

- HMI cable
- Magnet cable
- HMI controller and clipper switch for magnet activation

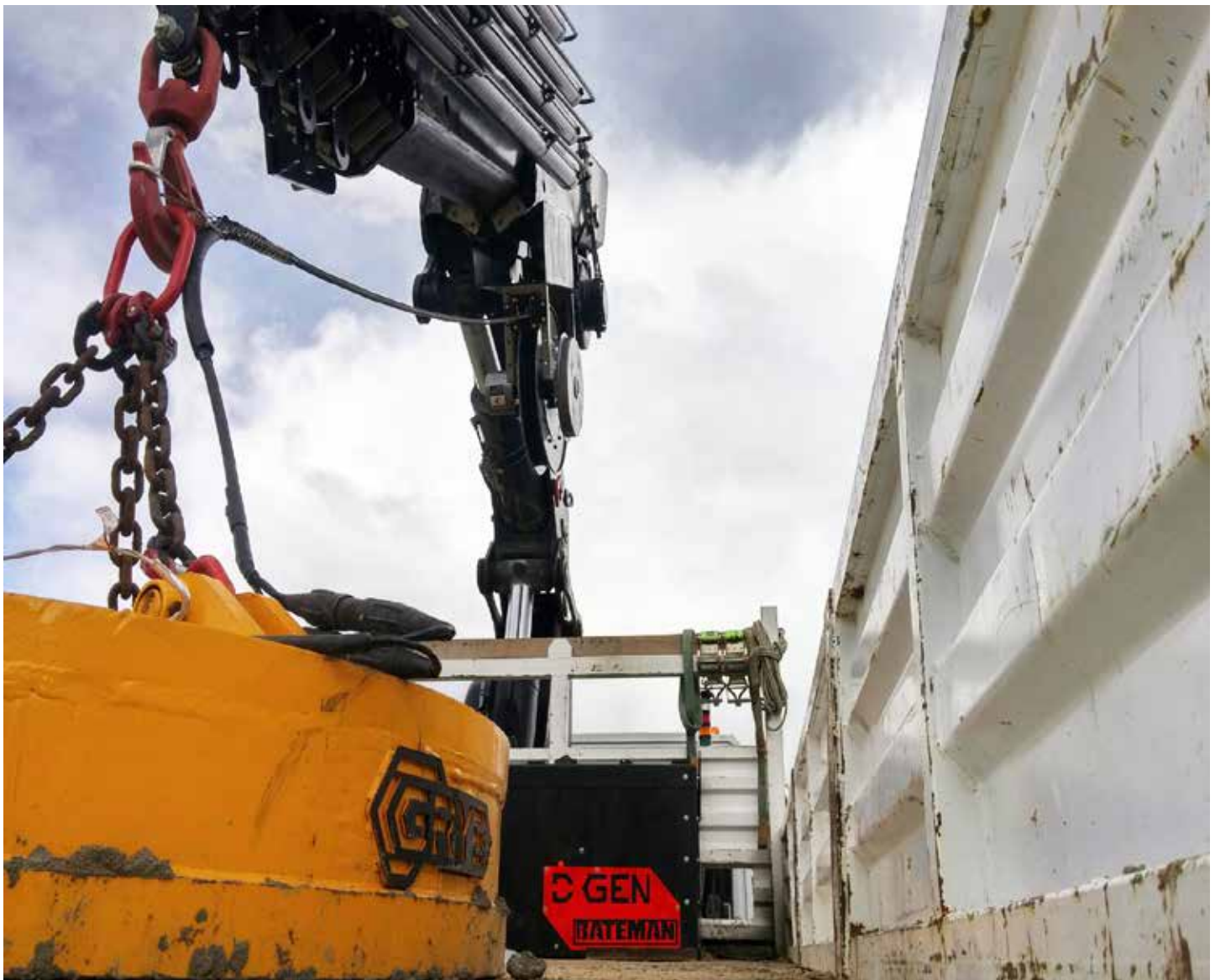



GMD Series

MAGNETIC BUCKET

MAGNETIC TOOTH BUCKET



MAGNET COMPLETELY INTEGRATED TO YOUR TOOTH BUCKET DIG, SORT, DEMOLISH, AND MAGNETIZE WITH ONLY ONE MULTI-PURPOSE TOOL.

- IDEAL FOR DEMOLITION WORK
- AVAILABLE FOR EXCAVATORS RANGING FROM 16 TO 90 TONS.
- AVAILABLE IN 230VDC OR 24VDC VERSIONS
- FULLY PROTECTED SUPPLY WIRES



Ideal for sorting material with a thumb





PHM Series

HYDRAULIC PULVERISER

DEMOLITION TOOL

CRUSHING POWER UP TO 150 tons!

High performance cylinder with high-speed valve with a cycle time of less than 6 seconds (optional).



Available with or without electromagnet



- Several types of interchangeable teeth
- Available with or without rotation
- 5 models available
- Optional magnet (24v or 230v)
- Ranging from 10 to 50 tons

Specifications

ELECTROMAGNETS

SCRAP MAGNET

Powergrip



MODEL NUMBER	DIAMETER (IN)	AMPERAGE	VOLTAGE (VCD)
PG30	30	21.5	230
PG36	36	27	230
PG40	40	38	230
PG48	48	45	230
PG57	57	58	230
PG63	63	82	230

Specifications

ELECTROMAGNETS

SCRAP MAGNET

Xtremgrip



MODEL NUMBER	DIAMETER (IN)	AMPERAGE	VOLTAGE (VCD)
XG68	68	88	230
XG72	72	115	230
XG78	78	125	230
XG87	87	150	230
XG96	96	180	230

Specifications

ELECTROMAGNETS

HYDRAULIC MAGNET



MODEL NUMBER	DIAMETER (IN)	AMPERAGE	VOLTAGE (VCD)
HYDMAG-PG36	36	22	230
HYDMAG-PG40	40	34	230
HYDMAG-PG48	48	38	230
HYDMAG-PG54	54	55	230
HYDMAG-XG60	60	61	230
HYDMAG-XG66	66	80	230

Specifications

ELECTROMAGNETS

BATTERY MAGNET



MODEL NUMBER	DIAMETER (IN)	AMPERAGE	VOLTAGE (VCD)
BM28A	28	85 / 42	12 OR 24
BM32A	32	85 / 42	12 OR 24
BM36A	36	40 / 80	24
BM40A	40	40 / 80	24
BM48A	48	50 / 100	24

* Other models and shapes available on request.

* Indicated weights exclude female couplers.

POWER (KW) REQ.	WEIGHT (LB)	HMS1	HMS2	TURNINGS
5	1,050	400	300	120
6.2	1,350	725	475	250
8.8	1,940	900	600	350
10.4	2,900	1,900	1,200	600
13.3	4,220	2,850	1,800	950
18.9	5,630	3,800	2,400	1,150

POWER (KW) REQ.	WEIGHT (LB)	HMS1	HMS2	TURNINGS
20	6,600	4,600	3,000	1,450
26.5	8,300	5,200	3,150	1,550
28.75	10,300	5,700	3,800	2,000
34.5	16,200	-	-	-
41.4	18,800	-	-	-

GENERATOR POWER	WEIGHT (LB)	HMS1	HMS2	TURNINGS
9	1,850	725	475	250
9	2,300	900	600	350
9	3,615	1,750	1,200	600
15	4,200	2,300	1,550	700
15	6,800	3,400	2,100	1,020
15	7,800	4,500	3,000	1,350

WEIGHT (LB)	LIFT CAPACITY HMS1 (LB)	DUTY CYCLE (%)
950	UP TO 400	75
1,300	UP TO 600	75
1,900	UP TO 750	75
2,415	UP TO 900	75
3,375	UP TO 1,100	75

ALL OF OUR SOLUTIONS ARE PERFECTLY ADAPTABLE TO THE MACHINERY AND THE SPECIFIC REQUIREMENTS OF CONTRACTORS IN SEVERAL INDUSTRIES, SUCH AS THE PORT INDUSTRY.



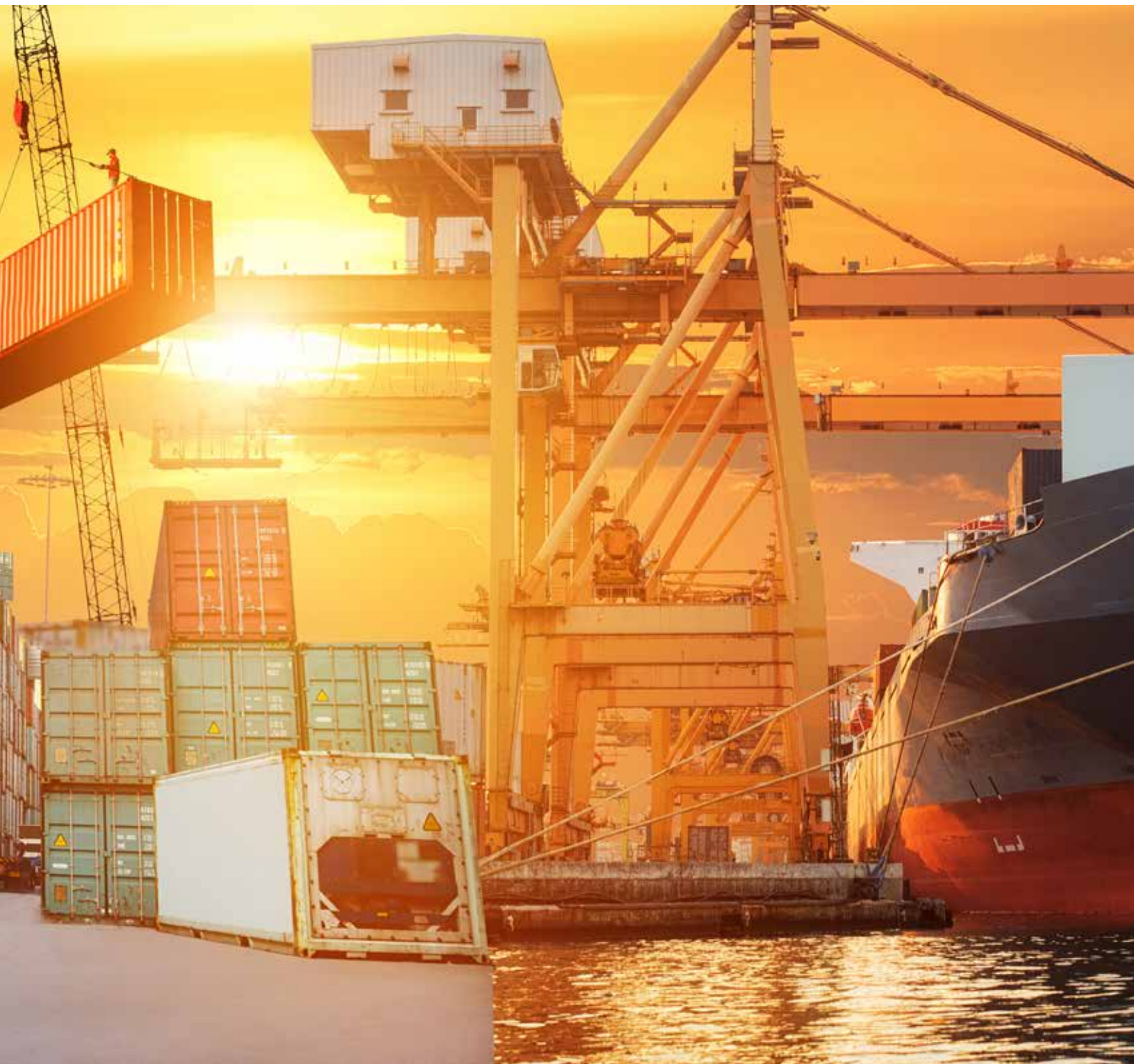

LIFTING

DIVISION \ GRYB



GRYB specializes in the creation and fabrication of lifting products designed to support the port, transport, industrial, and railway industries. These lifting solutions are designed to be fully compatible with to the specialized equipment of these sectors. We also offer our clients the option to design their own custom attachments specifically for their unique needs.



C-HOOK Series

C-HOOK



MOVE AND POSITION HEAVY COILS WITH A LIFTING MACHINE

DESIGNED TO LIFT HEAVY OBJECTS

CUSTOM MADE

We offer our clients the opportunity to design their own custom attachments for their unique needs.

- AVAILABLE IN A VARIETY OF DIMENSIONS AND CAPACITIES

- SUPPORT (OPTIONAL)

- BUMPER TO PROTECT THE COIL

DESIGNED TO SAVE SPACE!



PRO Series

PRONG



MOVE AND POSITION HEAVY COILS WITH A LOADER

DESIGNED FOR HANDLING ROLLS OR SHEETS OF STEEL, ALUMINUM, AND MORE!

Several lengths and capacities available.

- ATTACHES TO THE UNDERCARRIAGE

- STRONG STRUCTURE

- INCREASED VISIBILITY



BFI Series

SPREADER BEAM

LIFTING AND HANDLING SOLUTIONS CUSTOMIZED TO YOUR NEEDS



CUSTOM DESIGN

We specialize in the creation and fabrication of products designed to support the port, railway, and storage industries.

Lifting and handling solutions are adaptable to the extreme conditions and the specialized equipment of these areas of activity. Thanks to our engineering department, we also offer our clients the possibility to create unique projects that can be tailored to their reality.



DIMENSIONS AND CAPACITIES ADAPTED TO YOUR NEEDS

AVAILABLE IN A VARIETY OF CONFIGURATIONS AND APPLICATIONS

- HANDLING IS CONDUCTED BY CRANE, A LIFT TRUCK, OR AN EXTENDABLE LOADER ARM

- AVAILABLE WITH ELECTROMAGNETS



CLS Series

CONTAINER SPREADER FRAME



- IDEAL FOR AUTOMATIC OR MANUAL CRANES
- FOR 20 FT OR 40 FT CONTAINER
- MODEL AVAILABLE FOR LOADER

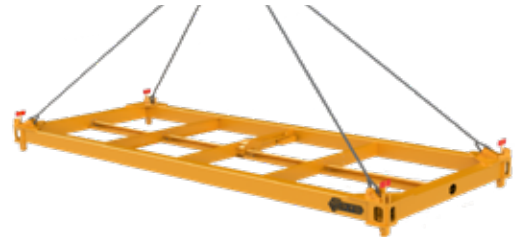

TEST STATION

Capacity of 150 TONNES

- ALLOWS TESTING OF LIFTING EQUIPMENT UP TO 50 'X 10' X 17 'DIMENSIONS
- ALSO AVAILABLE FOR ELECTROMAGNET

ALSO AVAILABLE

- Analysis of welds
- Equipment certification
- Annual testing
- Certificate of conformity



MACHINE MODIFICATIONS

DIVISION \GRYB



CONSTRUCTION



DEMOLITION



At GRYB, we have extensive experience designing and manufacturing customized products. We specialize in the creation and fabrication of long and high-reach products as well as accessories for excavation and demolition applications. We're proud to also offer safety and protection accessories for your machine.





LR Series

LONG REACH

TAKE YOUR PROJECTS TO A WHOLE NEW LEVEL



CUSTOM MADE

- LENGTH ADAPTED TO YOUR REQUIREMENTS
- OPTIMIZED WEIGHT
- FITS ALL MAKES OF EXCAVATORS
- CARRY OUT DIFFICULT TASKS

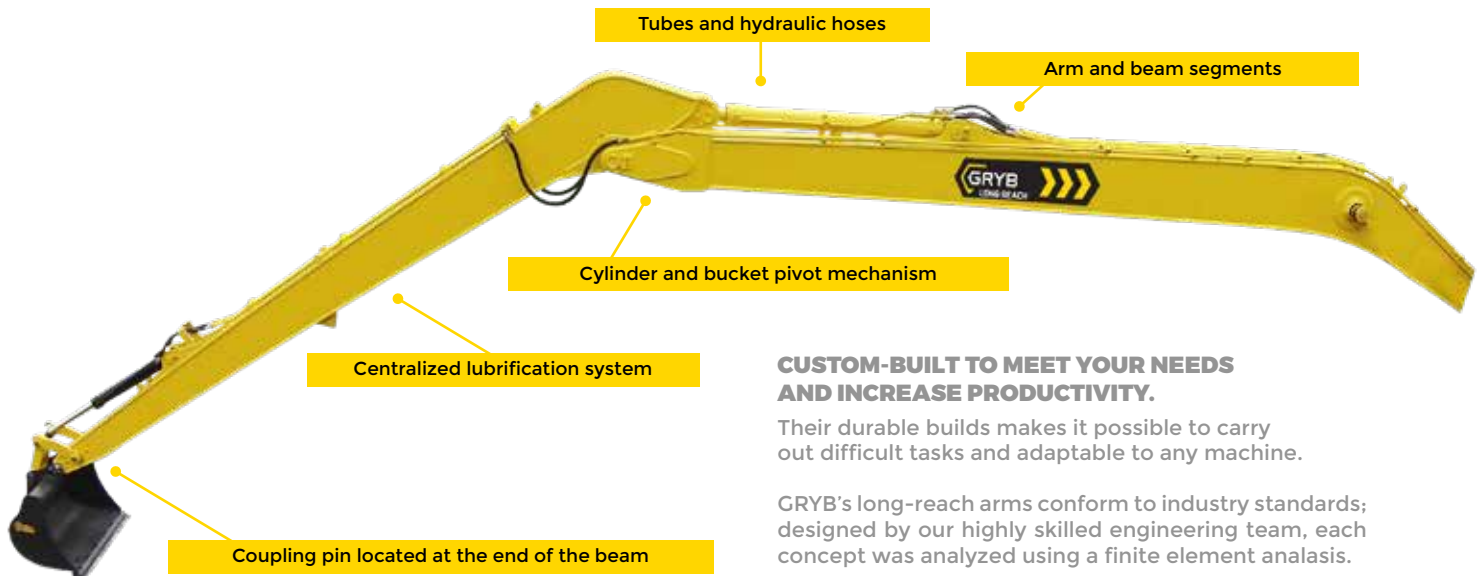

CUSTOM-BUILT TO MEET YOUR NEEDS AND INCREASE PRODUCTIVITY.

Their durable builds makes it possible to carry out difficult tasks and adaptable to any machine.

GRYB's long-reach arms conform to industry standards; designed by our highly skilled engineering team, each concept was analyzed using a finite element analysis.

The smooth and stable operation as well as optimal distribution ratio of weight-strength (resistance) of our arms brings them to a whole new level.





GRYB designs and manufactures long-reach booms for all types of excavators to enable our clients to accomplish their most demanding projects.

APPLICATIONS

- Dredging of rivers and oceans
- Excavation of deep foundations
- Construction of ditches
- Construction of coastal dikes
- Pond dredging





HR Series

HIGH-REACH ARM

DEMOLITION OF HIGH BUILDINGS AND ROAD INTERCHANGES



SPECIALLY DESIGNED TO WORK WITH YOUR DEMOLITION EQUIPMENT

- IDEAL FOR TIGHT-SPACE DEMOLITION
- A HIGHLY SKILLED ENGINEERING TEAM ACHIEVED ITS DESIGN

With its wide-operating range, it allows the execution out of demolition activities safely

- Its build makes it easily adapted to any machine
- A variety of options available

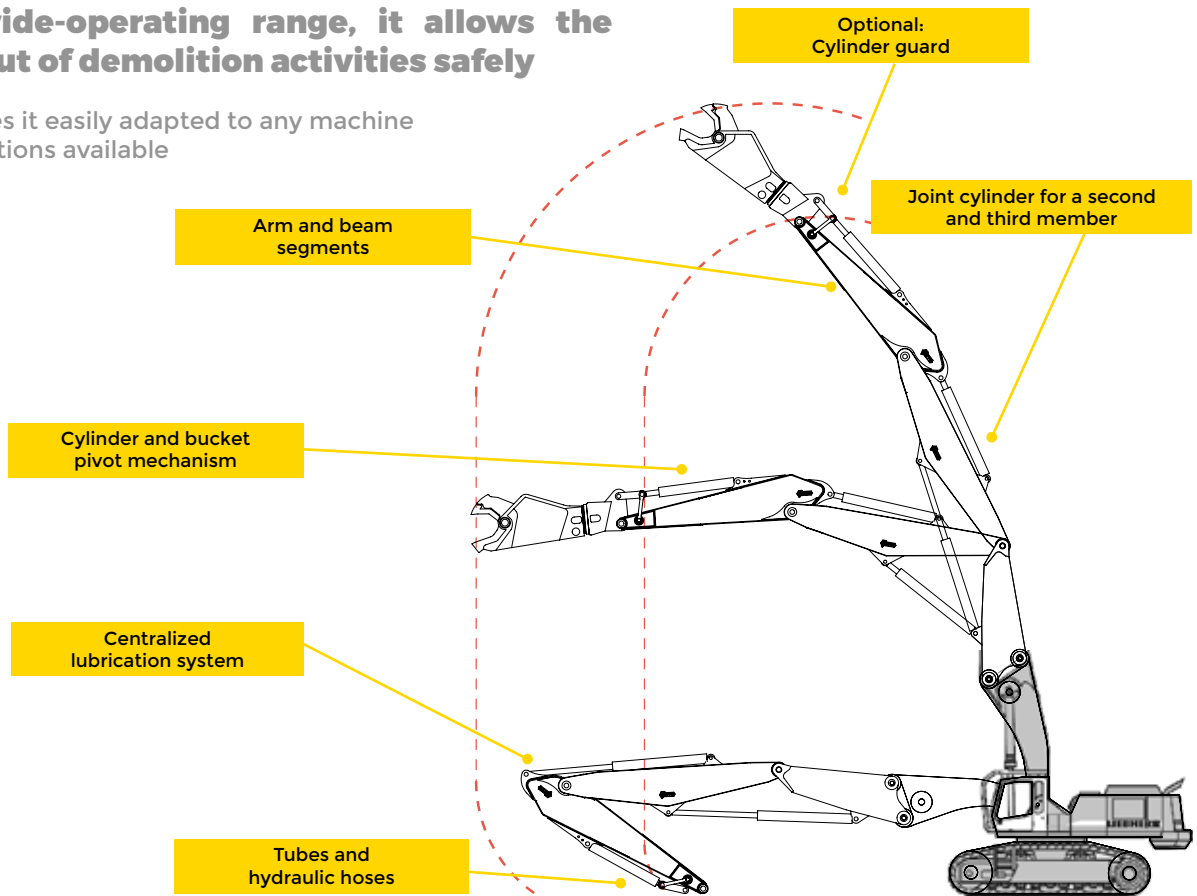

AVAILABLE

- Cabin protection
- Excavator protection
- Hydraulic or mechanical traction available
- Counterweight
- Range limiter

WARRANTY

1
YEAR

BDR Series

DEMOLITION ARM

DESIGNED FOR THE DEMOLITION OF HIGH WOODEN STRUCTURES

IDEAL FOR HIGH DEMOLITION WORK (LIGHTWEIGHT)

- COMPATIBLE WITH ALL EXCAVATOR BRANDS
- THE BOLTED HEAD ALLOWES THE USE OF VARIOUS FORMS OF CLAWS



Kit of bolting female couplers

Arm

Bolted plate

PROPOSED COMBINATION

Female couplers on a bolted plate allow the use of the demolition arm on multiple excavators.





LS Series

BOOM AND STICK



ACTS AS AN INTERMEDIARY BETWEEN THE ORIGINAL BOOM AND THE LONG-REACH BOOM

AFFORDABLE WAY TO INCREASE THE WORK RANGE

FUNCTIONAL ATTACHMENT THAT MEETS THE HIGHEST INDUSTRY STANDARDS.



OPTIONS

- Counterweight
- Wide range of buckets
- Quick-couplers
- Attachment guidance system (depth)
- Auxiliary hydraulic system
- Proximity switch (rear sensor)
- Extra LED lights
- Stick cylinder
- Cylinder and bucket's pivot mechanism

*Also available in the drop nose model for material handling.





SE Series

BOOM AND STICK EXTENSION

EASILY ADAPTED TO YOUR MACHINE



ALLOWS QUICK SWITCHES BETWEEN A LONG-REACH EXCAVATOR AND THE ORIGINAL EXCAVATOR.

FINITE ELEMENT METHODS OF ANALYSIS ARE EMPLOYED TO ENSURE PRODUCT RELIABILITY AND DURABILITY. LIGHT-DUTY DREDGING.

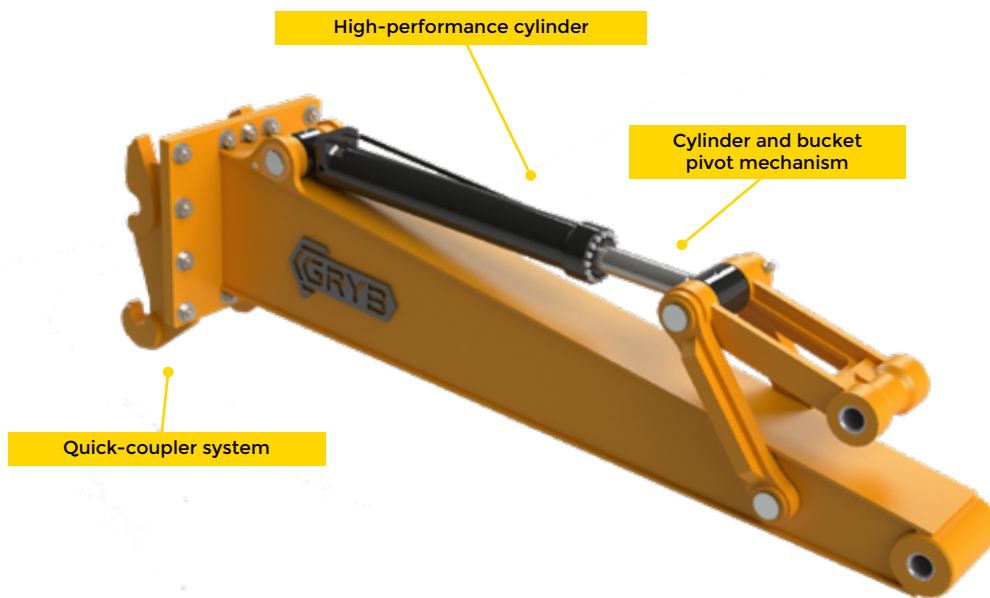

INCREASES THE WORK RANGE OF THE EXCAVATOR AND WIDENS THE RANGE OF POSSIBLE OPERATIONS.

Several lengths available for each excavator.

OPTIONS

- Counterweight
- Wide range of buckets available
- Quick-coupler
- Attachment guidance system (depth)



MH Series

SPECIALIZED ARM FOR HANDLING MATERIALS



EMPTY BARGES, BOATS, AND TRAINS

WORK NEARBY, AT A DISTANCE, OR HEIGHTS.
FASTER AND EFFICIENT MATERIAL SORTING.

ALSO DESIGNED FOR WOODCOURSES, RECYCLING CENTERS, AND SCRAPYARDS.

- Allows you to attain hard-to-reach places
- Provides high stability

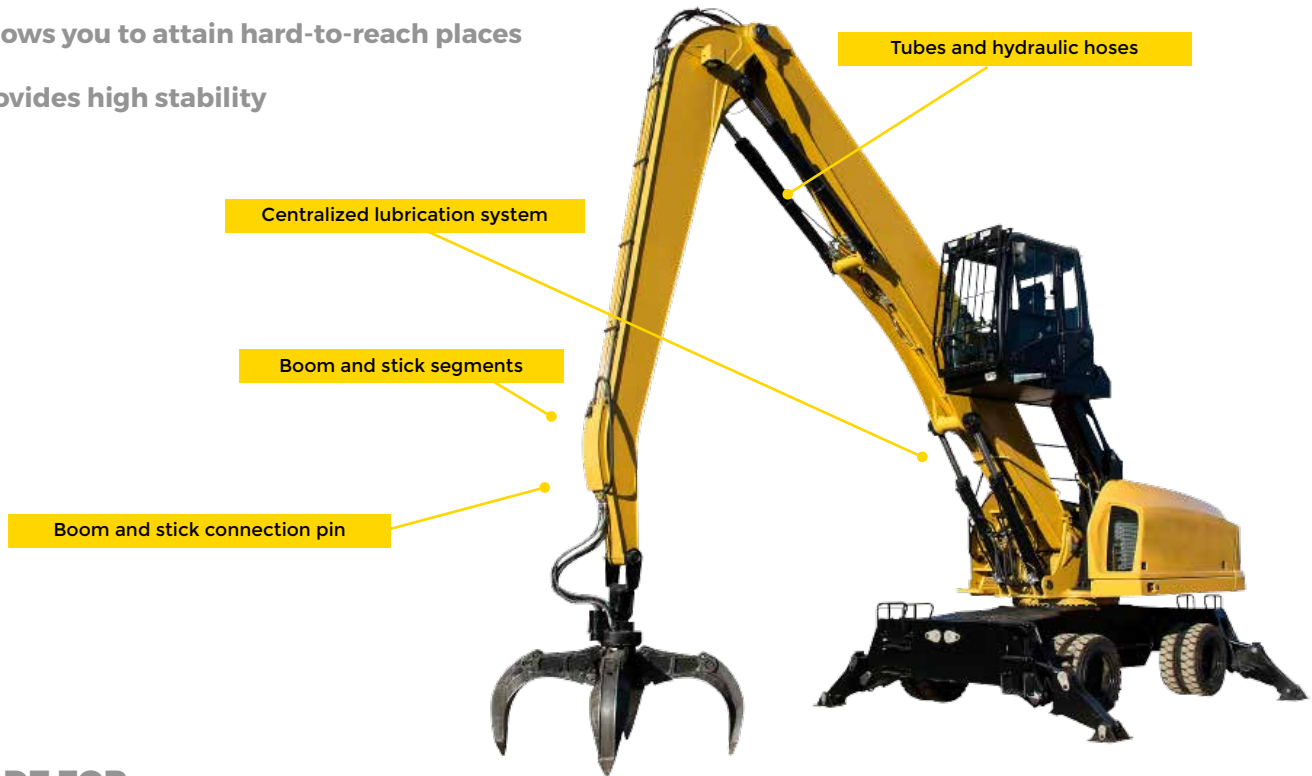

MADE FOR:

- WOOD YARDS
- RECYCLING CENTERS
- SCRAPYARDS

ALSO AVAILABLE:

- HYDRAULIC CABIN INCLINATION
- HYDRAULIC CABIN ELEVATOR
- FIXED CABIN LIFTER

**DESIGNED TO MEET THE
NEEDS OF OUR CUSTOMERS
AND OFFER OPERATORS
SUPERIOR CONTROL.**



SPECIAL PROJECTS



SALES PROGRAM

BECOME A DEALER!

We are currently looking for distributors interested in selling or distributing our products.

We cooperate with our distributors to provide useful selling tips and a complete understanding of our products.

We offer an attractive discount program.

Financing plan available.

SALES SUPPORT

- A full-time, on-the-road sales team providing sales support
- Personalized training program for each distributor
- On-site measurements
- Customized designs tailored to our customers' needs
- Replacement parts available express (24 h)
- Large highly skilled engineering team
- Big, complete, efficient service team
- Technical support and demonstrations during trade shows
- Marketing support (flyers, datasheets, advertisements, newsletters, videos, website)
- Enhancement of our customers' visibility



If you have any questions, please feel free to contact us:

1 844 604-1396 | info@gryb.ca | GRYB.COM

GRYB is a passionate, innovative, and dynamic team coordinated to respond quickly and efficiently to each of its clients.

Our vast network of representatives and technicians are always ready and available.

We also offer a multitude of solutions, custom and turnkey projects, financing options, equipment loans, and large and small tips that make the difference.

All solutions are good when it comes to simplifying our clients' workload. Our corporate culture is innovation-based and our clients reap the benefits.



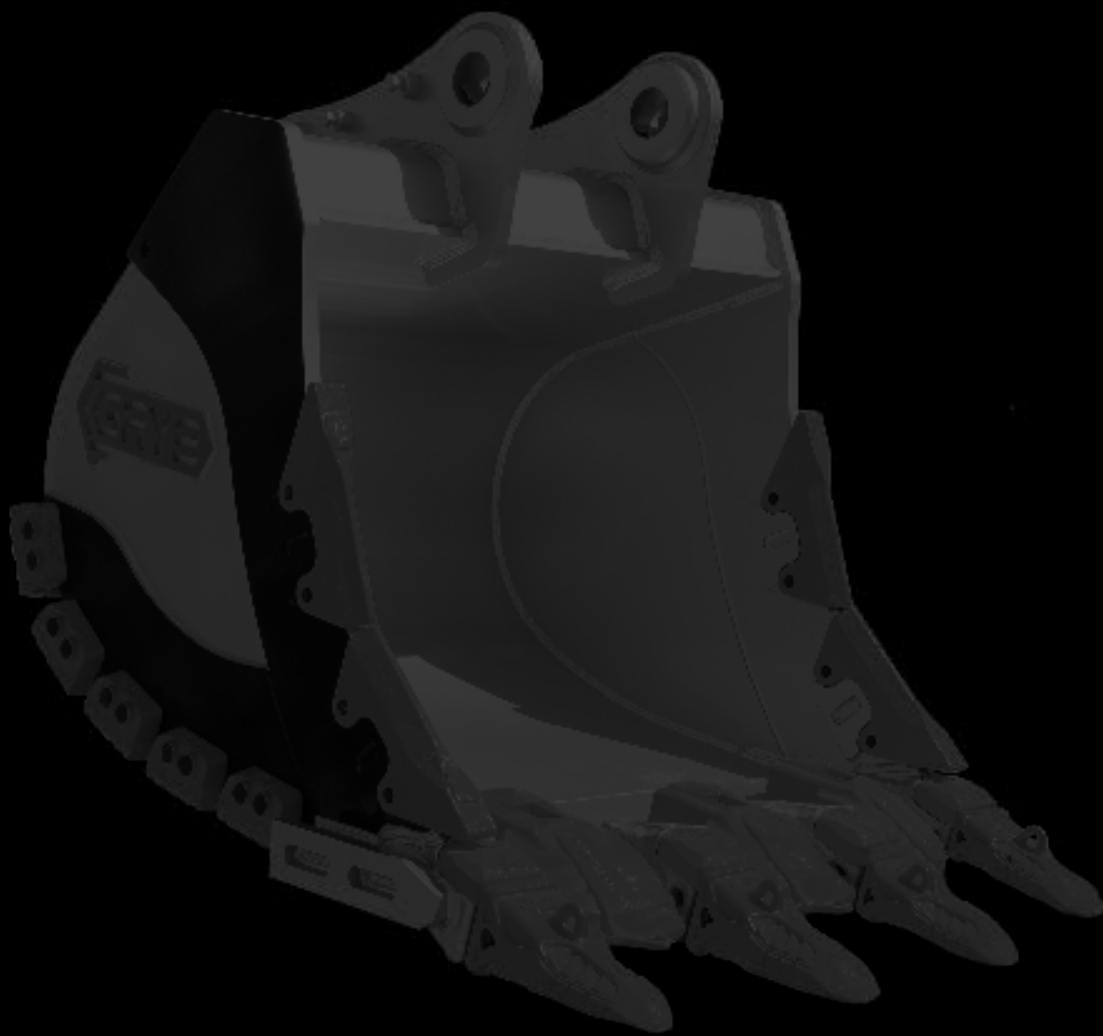

GRYB.COM

info@gryb.ca | 1 844 604-1396

1400 boulevard Pierre-Roux Est, Victoriaville (Québec) G6T 2T7, Canada